

HYDROSTORM ECO-V 150

Energy Saving Variable Speed Pump



- Slash Energy Use By Up To 88%.
- Ultra Quiet Operation.
- Enhanced Water Clarity.





HYDROSTORM **ECO-V** 150

Energy Saving Variable Speed Pump

Hydrostorm ECO-V 150 is designed to have all the extra power you need to cope with modern day swimming pool designs, but is equipped with an energy saving variable speed motor that offers the finest adjustment in operating speed with 25 RPM increments, allowing fine tuning of the pump's motor speed to perfectly match the flow requirements of the swimming pool, maximising energy savings and minimising pump noise.

- Energy Rating of 5 Stars
- Variable permanent magnet brushless DC motor
- Ultra quiet operation

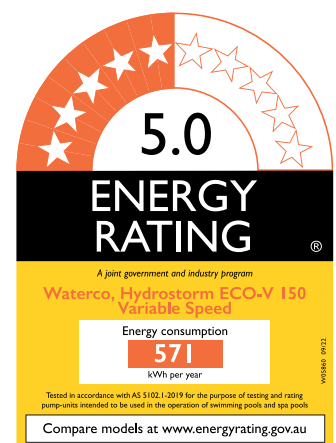

SLASH ENERGY USE BY UP TO 88%.

Energy Saving

A pool filtration system does not require to be operated at a pump's maximum water flow rate as with the use of a conventional pool pump limited to one speed. In fact, your pool's filtration efficiency improves at lower flow rates.

As a pool's filtration cycle occupies 99% of the run time of a pool pump, you can operate the Hydrostorm ECO-V 150 on its low (ECO) speed setting for a majority of its running time, leading to a potential 88% savings in energy.

Equipped with the very latest variable speed permanent magnet brushless DC motor, Hydrostorm ECO-V 150 is capable of lowering its motor speed, reducing water flow and lowering its energy consumption.

Variable Speed Options

Hydrostorm ECO-V 150's variable speed options cater for most pool functions.

High speed

Vacuuming and backwash - 1% of the time

Medium speed

Automatic pool cleaners

Low speed

Filtration - 99% of the time

Variable speed

Hydrostorm ECO-V 150 has 3 factory set speed options ECO (low), MED & HIGH but with the additional advantage of fine adjustment in operating speed with 25 RPM increments, allowing fine tuning of the pump's motor speed to perfectly match the flow requirements of the swimming pool, maximising energy savings and minimising pump noise.

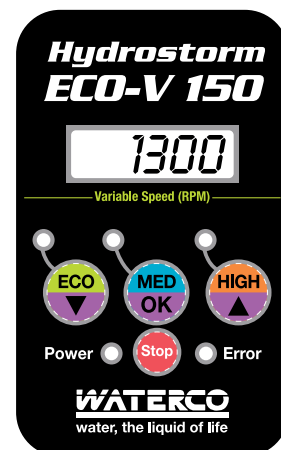

PERFECTLY MATCH
FLOW REQUIREMENTS
AND MAXIMISE ENERGY
SAVINGS.

SAVE HUNDREDS OF DOLLARS OFF YOUR ENERGY BILLS.

Ultra Quiet

Hydrostorm ECO-V 150 operates most economically and with the lowest noise level at its low speed setting. Its low speed setting significantly reduces the pump's vibration, motor noise and water turbulence to an ultra low 55 decibels (dBA).

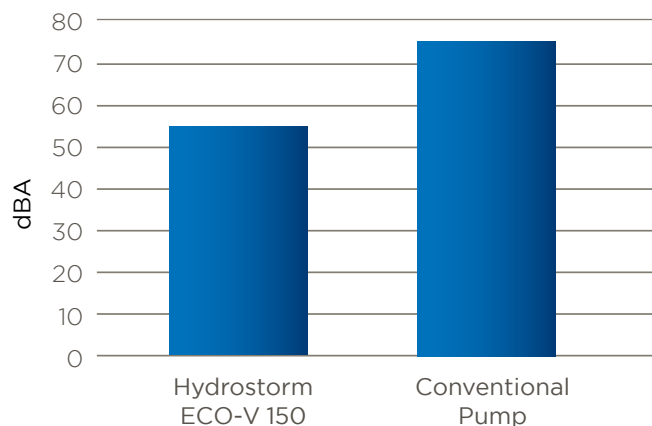

Off-Peak Operation

Its low noise levels enable it to be operated at times that are not allowable for conventional pool pumps. A Hydrostorm ECO-V 150 allows you to take advantage of off-peak electrical tariff periods, without upsetting your neighbours.

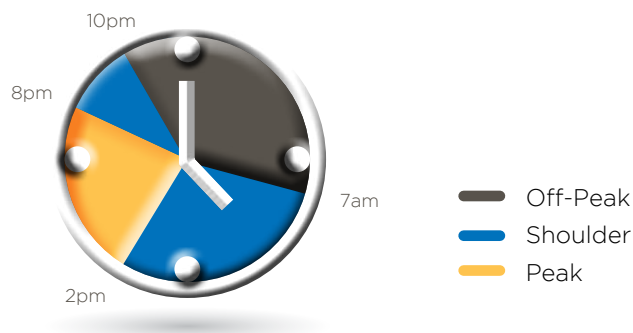

ENHANCE WATER CLARITY

Benefit of Slow Flow

Lowering a pump's flow rate not only significantly decreases the pump's energy requirements, but also reduces water flow resistance in your pool equipment and plumbing. Even though you may need to operate the Hydrostorm ECO-V 150 longer, it is far more efficient pumping low water flow compared to high water flow.

A slow flow rate also has the added benefit of improving your pool's filtration efficiency, enhancing the clarity of your swimming pool water. Plus your automatic chemical dosers and salt chlorinators are also more effective when the pool water is circulated longer.



KEY FEATURES

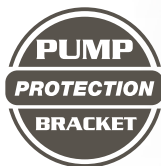

Motor protection bracket. This protection bracket adds a 61mm separation between the pump wet end and motor. The bracket also has larger drain holes for improved draining of any water leaks due to long term usage wear of the main mechanical seal.

1. Variable speed control panel, IP55 rating
2. Permanent magnet brushless Variable speed DC motor
3. UV stabilised & corrosion resistant
4. 50mm quick connect barrel unions for UPVC pipe
5. Clear basket lid & large 2.1 litre strainer basket
6. High grade carbon / graphite mechanical seal with 316 stainless steel spring assembly
7. Strong single piece glass filled thermoplastic pump body
8. Drain plugs
9. Stable support base
10. Hydraulically efficient impeller and diffuser design
11. Fan cooled thermal overload protection

Hydrostorm ECO-V 150 Performance Curves

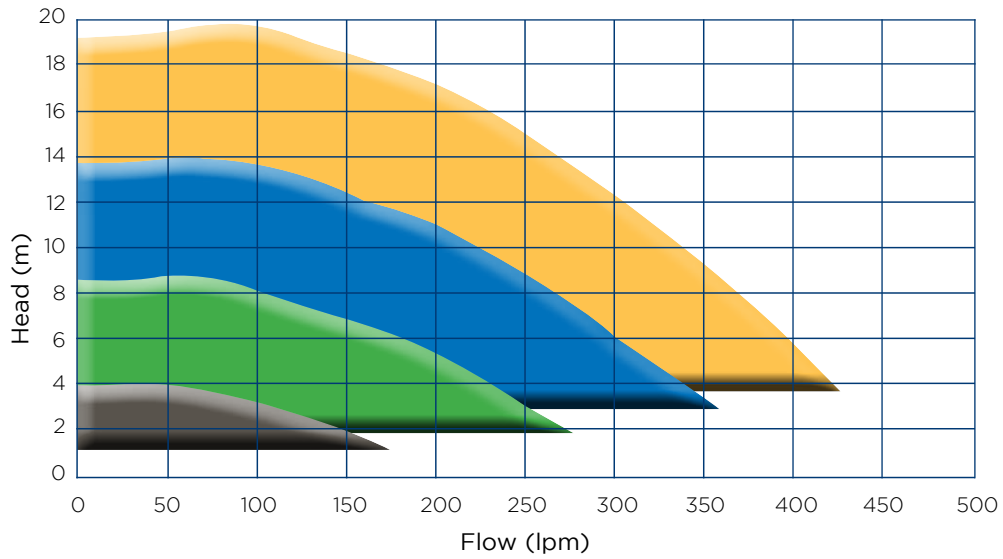

Hydrostorm ECO-V 150 Noise Levels

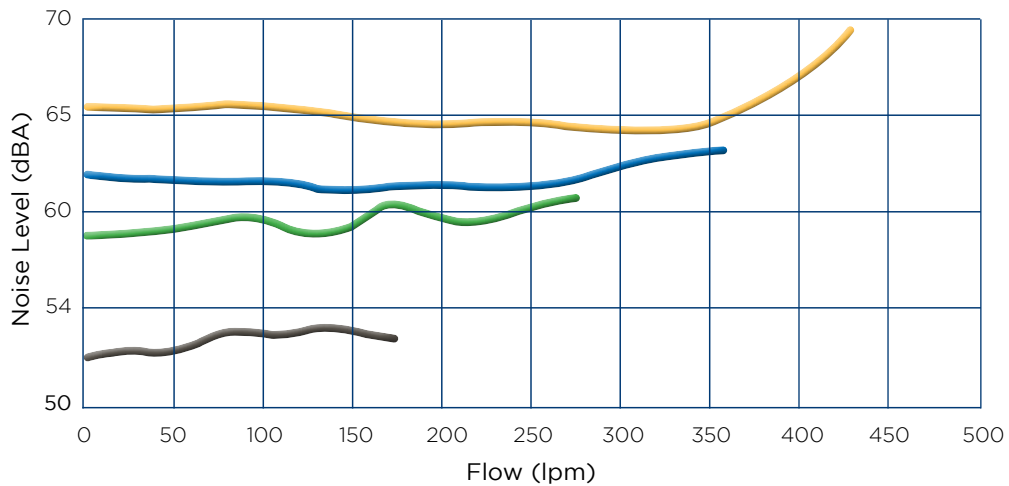

- ECO-V speed (1300rpm)
- ECO speed (1900rpm)
- Medium speed (2400rpm)
- High speed (2850rpm)

Warranty

Pumps	3 years (conditional)*
Wet End	3 years
Motor, mechanical seal, hair & lint pot lid, o'ring, basket, impeller & diffuser	2 years
Commercial applications	1 year
Labour	1 year

*Please refer to Waterco's warranty terms and conditions

Specifications

Length (mm)	Height (mm)	Width (mm)	Packaged Weight (kg)	Inlet/Outlet (mm)	Strainer Basket (lt)
771	340	227	14	50	2.1

ECO-V speed (1300rpm)

Pump Total Head (m)	Flow Rate (lpm)	Motor Input (kW)	Amps	Noise Level (dBA)
1.7	150	0.16	1.4	55.7
2.2	131	0.16	1.4	56.0
2.6	118	0.16	1.4	55.6

Medium speed (2410rpm)

Pump Total Head (m)	Flow Rate (lpm)	Motor Input (kW)	Amps	Noise Level (dBA)
5.2	309	0.78	5.5	69.7
6.9	280	0.78	5.5	71.4
8.8	240	0.78	5.5	71.5

ECO speed (1900rpm)

Pump Total Head (m)	Flow Rate (lpm)	Motor Input (kW)	Amps	Noise Level (dBA)
3.0	246	0.42	3.2	58.7
4.2	216	0.42	3.2	59.0
5.5	185	0.42	3.2	61.5

High speed (2850rpm)

Pump Total Head (m)	Flow Rate (lpm)	Motor Input (kW)	Amps	Noise Level (dBA)
6.4	375	1.25	8.5	78.3
9.5	336	1.26	8.6	77.3
12.3	290	1.26	8.6	76.3

Dimensions (mm)

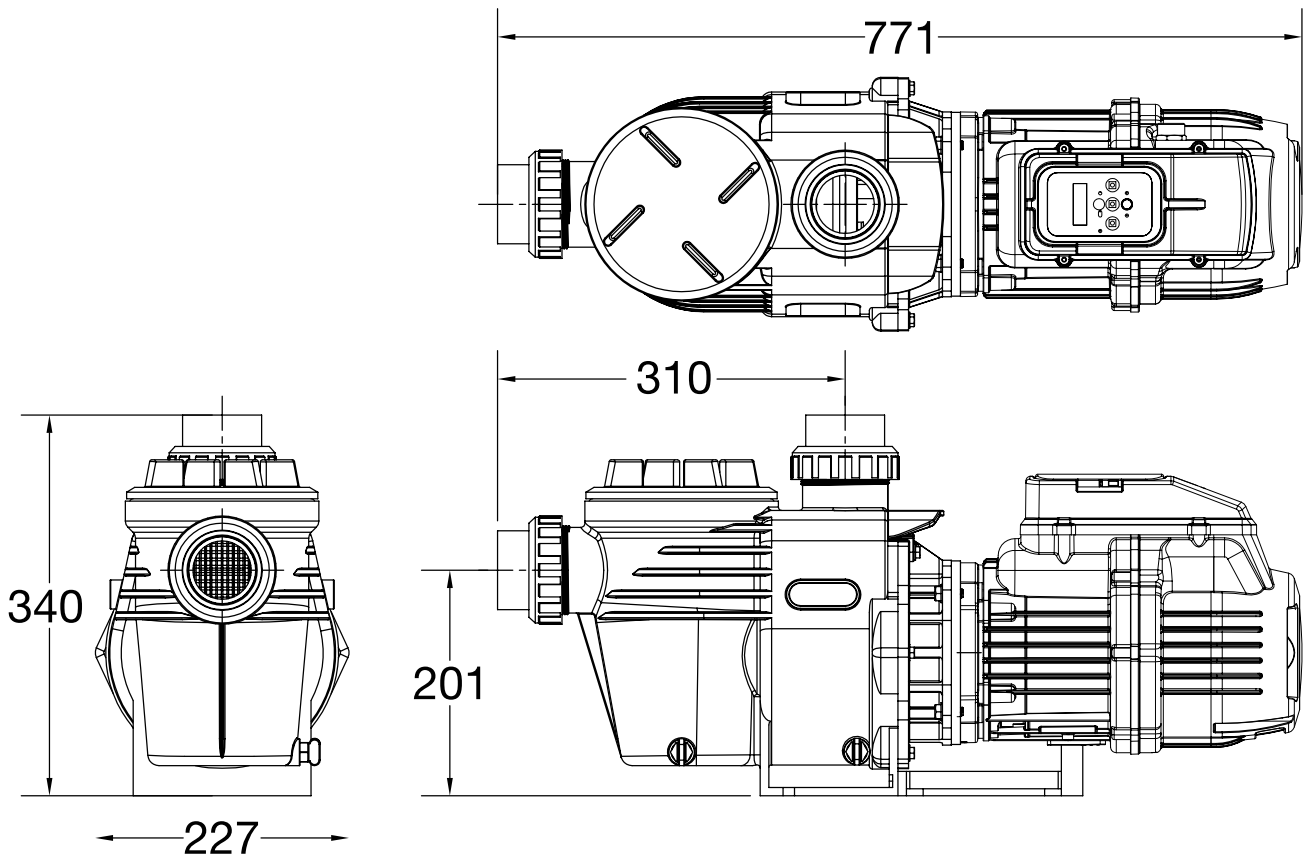

OFFICES - AUSTRALIA

NSW - Sydney (Head Office)
Tel: +61 2 9898 8686

QLD - Brisbane
Tel: +61 7 3299 9900

VIC/TAS - Melbourne
Tel: +61 3 9764 1211

WA - Perth
Tel: +61 8 9273 1900

SA/NT - Adelaide
Tel: +61 8 8244 6000

ACT Distribution
Tel: +61 2 6280 6476

OFFICES - OVERSEAS

Waterco (Europe) Limited
Sittingbourne, Kent, UK
Tel: +44 (0) 1795 521 733

Waterco (USA) Inc
Augusta, Georgia, USA
Tel: +1 706 793 7291

Waterco Canada
Boucherville, Qc, Canada
Tel: +1 450 748 1421

Waterco (NZ) Limited
Auckland, New Zealand
Tel: +64 9 525 7570

Waterco (C) Limited
Guangzhou, China
Tel: +86 20 3222 2180

PT Waterco Indonesia
Jakarta, Indonesia
Tel: +62 21 4585 1481

Waterco Singapore Intl Pte Ltd
Nehsons Building, Singapore
Tel: +65 6344 2378

Waterco (Far East) Sdn Bhd
Selangor, Malaysia
Tel: +60 3 6145 6000

Distributed by:



In the interest of providing better quality and value we are constantly improving and updating our products. Consequently, pictures and information on our brochures may sometimes vary slightly from models available.

ZZB1624 09/22